

2 1/2" x 8" SLAB SECTION

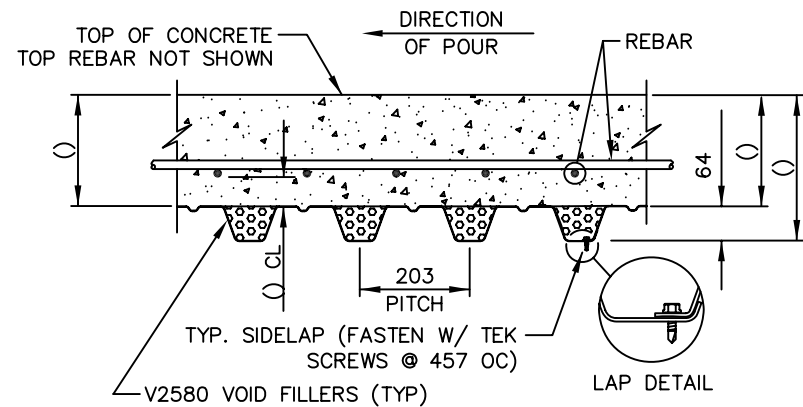

64 x 203 SLAB SECTION

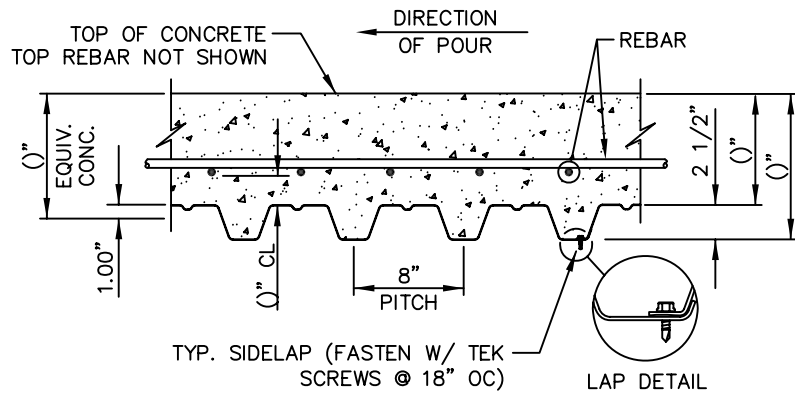

2 1/2" x 8" SLAB SECTION

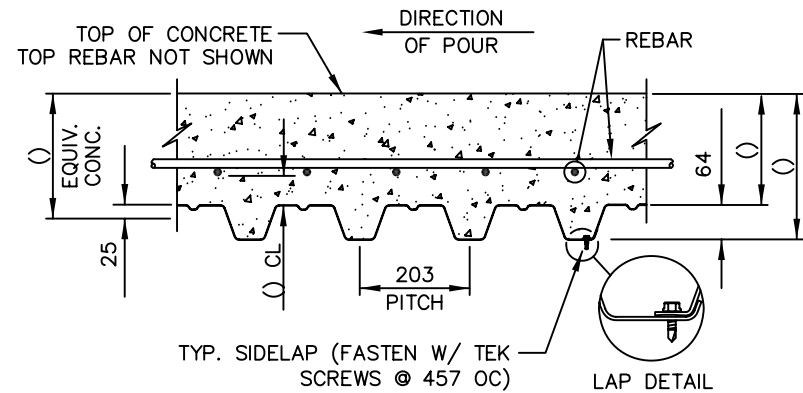

64 x 203 SLAB SECTION

CUSTOMER	
DESCRIPTION	
PROJECT	
LOCATION	



CONSOLIDATED SYSTEMS INC. MEMPHIS, TN

4900 HUNGERFORD RD.
MEMPHIS, TN 38118
1-800-624-0925
FAX 901-375-9357



DRWN	CHKD	DATE
CSI JOB NO.		